

Design

The diaphragm unit consists of:

- Diaphragm housing with connections for impulse tube and valve
- Spindle and tappet
- Supply valve adapter to install impulse tube to supply mains valve (suitable for V5000 Kombi-3-plus RED and V5100 Stop Valve-3)
- 4 x 1 mm impulse tube with compression fittings, length 800 mm
- 4 mm Allan key to change the pre-setting

Materials

- Diaphragm housing, spindle and diaphragm spring made of stainless steel
- Connection for impulse tube and valve, supply valve adapter, compression fittings and tappet made of brass
- Diaphragm and soft seals made of EPDM
- Impulse tube made of copper

Application

The V5012C Kombi-DP diaphragm unit is installed onto a V5010 Kombi-3-plus BLUE or V5032 Kombi-2-plus return mains balancing valve and connected to a V5000 Kombi-3-plus RED or V5100 Stop Valve-3 supply mains valve with the supplied impulse tube.

It is used in systems with variable volume flows, for example two-pipe heating systems or district heating exchangers, and supports a hydronic balance by keeping the differential pressure over consumers at a constant pre-set level even under changing flow conditions.

The V5012C Kombi-DP diaphragm unit can be fitted to the Kombi-Valves at any time, even when the system is under pressure and in operation – operation of the system does not have to be interrupted to install the V5012C Kombi-DP.

Features

- **Retrofittable without interrupting operation of the system**
- **Rugged design**
- **Two pre-setting ranges available: 0.1...0.3 bar or 0.3...0.6 bar differential pressure**
- **Suitable for V5010 Kombi-3-plus BLUE DN10...DN40 and V5032 Kombi-2-plus DN15...DN40**

Specifications

Medium	Water or glycol-water mixture, quality to VDI 2035
pH-value	8...9.5
Operating temperature	2...130°C (36...266°F)
Operating pressure	max. 10 bar (145 psi)
Differential pressure	max. 2.0 bar (29 psi)
Differential pressure pre-setting range	V5012C0103: 0.1...0.3 bar (1.45...4.35 psi) V5012C0306: 0.3...0.6 bar (4.35...8.70 psi)
Factory setting	V5012C0103: 0.1 bar (1.45 psi) V5012C0306: 0.3 bar (4.35 psi)
k_{vs} (cv)-values	see flow diagram and remarks on page 5

Function

The V5012C Kombi-DP diaphragm unit is installed onto a V5010 Kombi-3-plus or V5032 Kombi-2-plus return mains balancing valve and connected to a supply mains valve with the supplied 4 x 1mm copper impulse tube and compression fittings. Suitable supply valves are the V5000 Kombi-3-plus RED or the V5100 Stop Valve-3 which are both compatible with the supply valve adapter of the V5012C Kombi-DP kit.

The pressure of the supply pipeline is led to the Kombi-DP via the impulse tube and acts onto the top of the diaphragm, the pressure of the return pipeline is led to the Kombi-DP through the return valve and acts onto the bottom of the diaphragm.

When the supply pressure increases, the diaphragm inside the Kombi-DP is pushed down against the return pressure. The diaphragm acts onto the insert of the connected return valve and the flow is throttled.

When the supply pressure decreases, the diaphragm inside the Kombi-DP is pushed open by the return pressure. The diaphragm moves up, releasing the insert of the return valve and the flow increases.

The desired differential pressure can be preset from 0.1...0.3 or from 0.3...0.6 bar, depending on the type used.

Dimensions

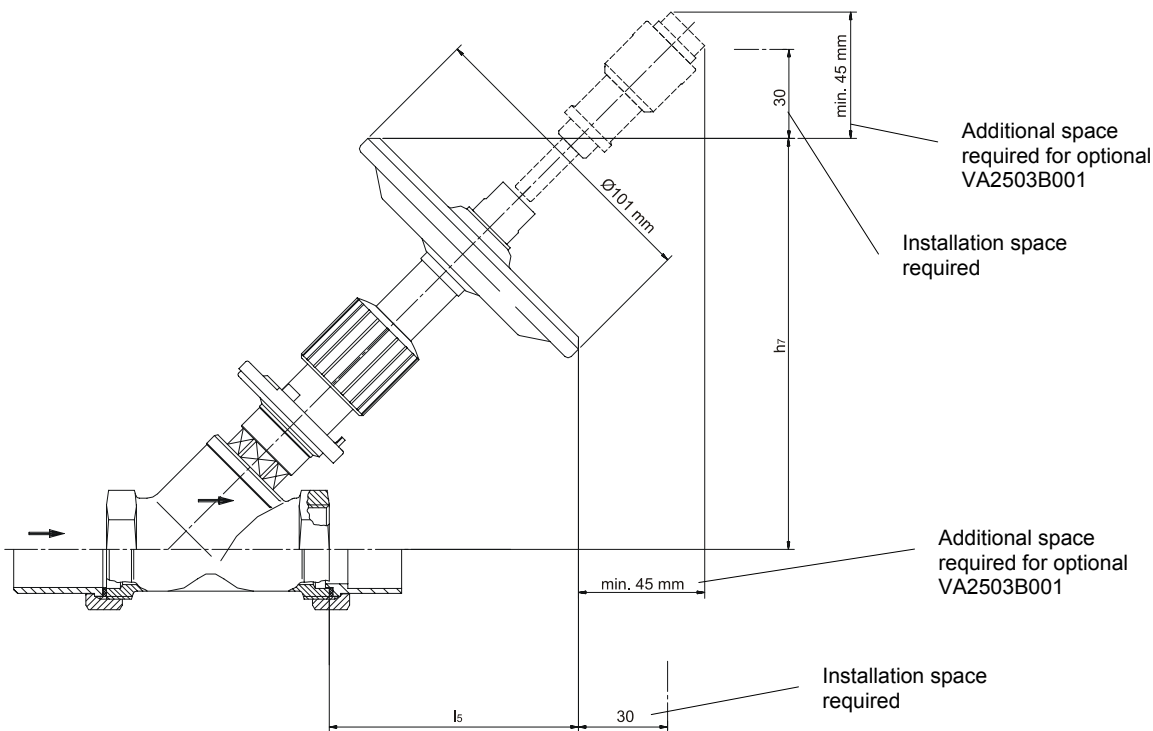

Fig. 1. V5012C Kombi-DP diaphragm unit with V5010 Kombi-3-plus BLUE or V5032 Kombi-2-plus

Table 1. Dimensions

Valve size DN	V5012C0103		V5012C0306	
	h7	l5	h7	l5
10	135	95	145	102
15	135	95	146	103
20	150	100	161	111
25	150	90	161	101
32	185	105	196	116
40	185	100	196	111

NOTE: The V5012C is not supplied with valve.
All dimensions in mm.

Ordering Information

Table 2. OS-Nos. (OS=Ordering System)

Order text	Pre-setting range	OS-No.
V5012C Kombi-DP diaphragm unit	0.1...0.3 bar (1.45...4.35 psi)	V5012C0103
	0.3...0.6 bar (4.35...8.70 psi)	V5012C0306

- Box contents**
- Diaphragm unit
 - Supply valve adapter
 - 4 mm Allan key
 - Copper impulse tube 4 x 1 mm, length 800 mm
 - Suitable compression fittings
 - Installation and operating instructions

Accessories

Spring to reduce differential pressure pre-setting by 0,05 bar (0,73 psi)

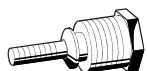

for V5012C0103 only

VA2502A002

Shutoff fitting R 1/4"



for all V5012 Kombi-DP

VS5501A008

External pre-setting device for installation between Kombi-Diaphragm Unit and impulse tube

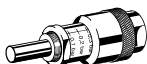

for V5012C0103 only (not with VA2504A001)

VA2503B001

Service Parts

Spindle assembly

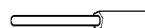

for all V5012C Kombi-DP

VS2500KDP1

Angle adapter



for all V5012 Kombi-DP

VA2504A001

Compression fitting for 4 x 1 mm copper impulse tube



for all V5012 Kombi-DP

VS5500A004

Compression fitting for 6 x 1 mm copper impulse tube



for all V5012 Kombi-DP

VS5500A008

Application Examples

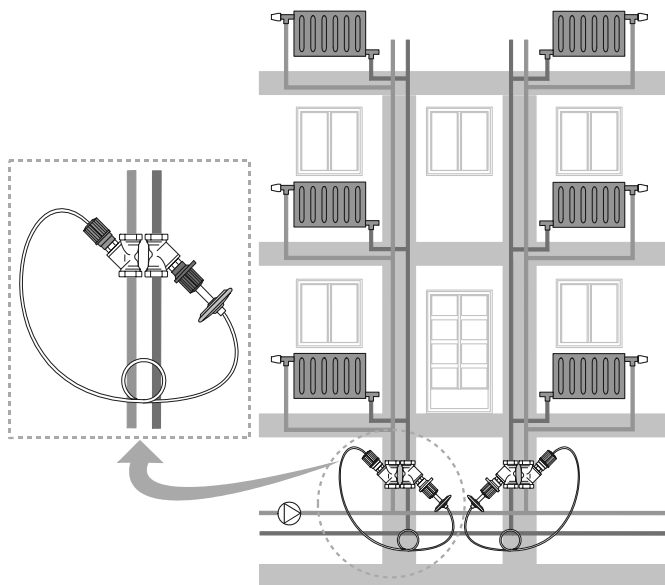

Fig. 2. V5012C Kombi-DP in a two-pipe heating system

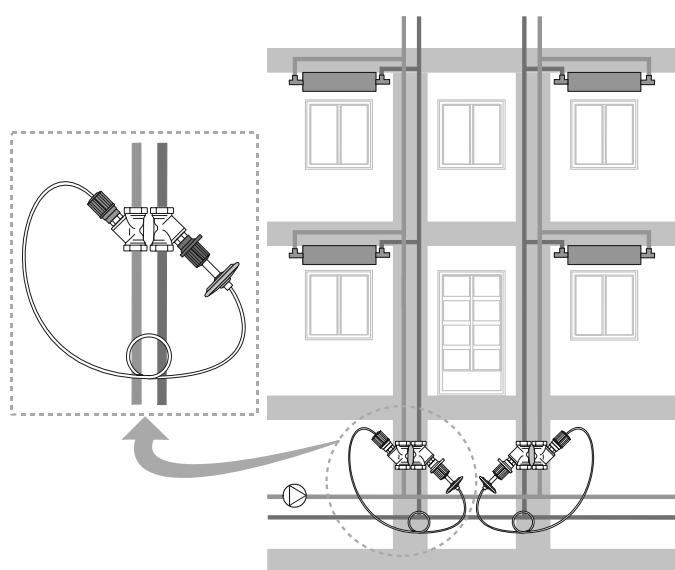

Fig. 3. V5012C Kombi-DP in a cooling system

Control Characteristics

NOTE: Below control characteristics refer to the combination of a V5012C Kombi-DP with a V5010 Kombi-3-plus BLUE or V5032 Kombi-2-plus balancing valve.

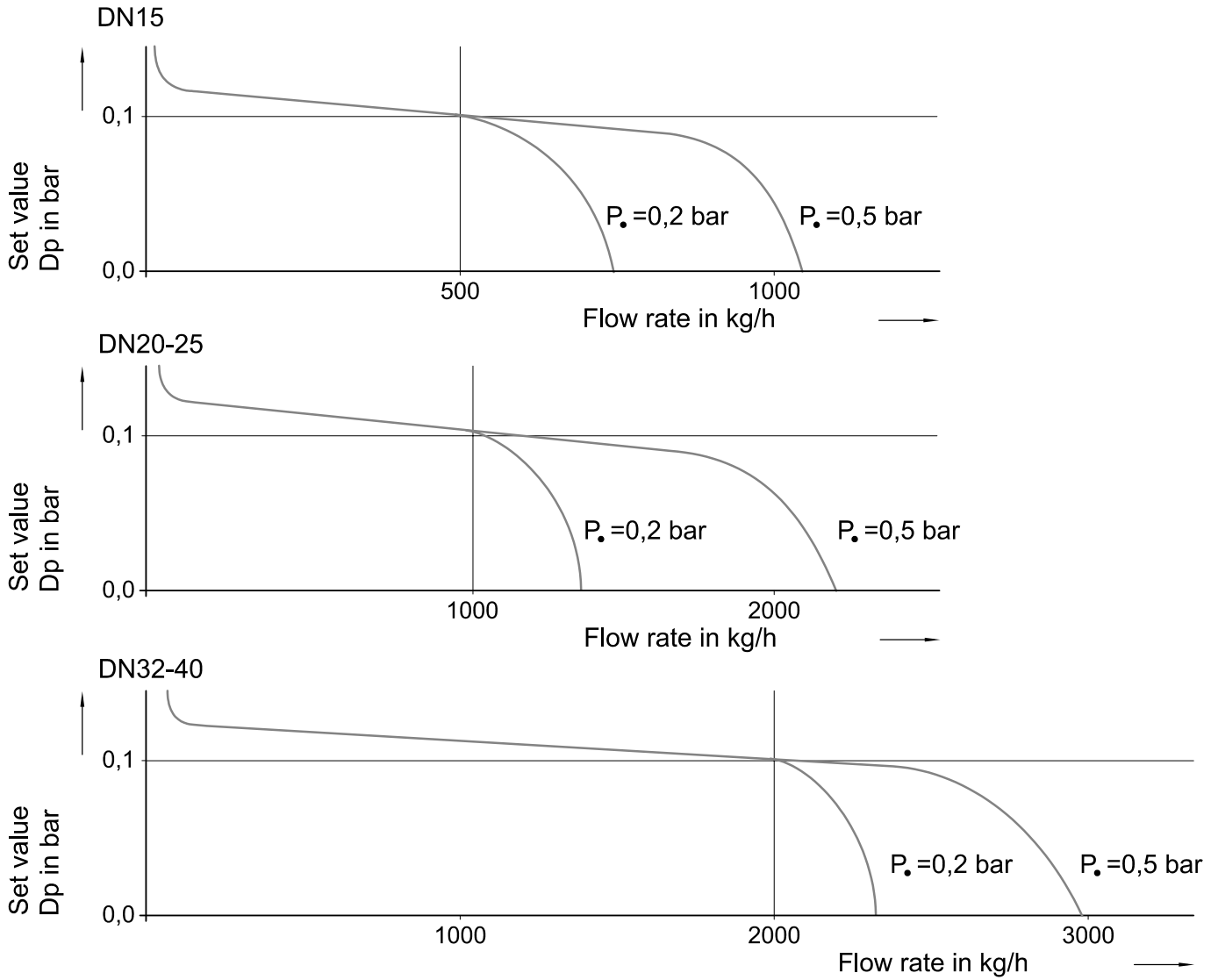

Fig. 4. Control characteristic of V5012C0103, set at 0.1 bar Dp (factory setting)

Table 3. k_{vs} -values and flow rates

DN	10	15	20	25	32	40
k_{vs}-value	1.50	1.50	3.50	3.50	5.50	5.50
cv-value	1.76	1.76	4.10	4.10	6.44	6.44
Liter/h Q_{min}	20	20	40	40	80	80
Q_{nom}	500	500	1,000	1,000	2,000	2,000
Q_{max}	750	750	1,500	1,500	2,500	2,500

NOTE: The pump pressure must be set at least 0.1 bar above the pre-setting value, e.g. $D_p 0.3 \rightarrow P_0 0.4$ bar; $D_p 0.6 \rightarrow P_0 0.7$ bar. The total pressure drop across supply and return valve, taking the V5012C Kombi-DP pre-setting into account, can be calculated with Honeywell's Valve Sizing Software at www.honeywell-valvesizing.com.

The V5012C0103 is factory set to 0.1 bar. The pre-setting can be increased to max. 0.3 bar. In that case the control curve as displayed in Fig. 4 moves in parallel to the pre-setting value.

The V5012C0306 is factory set to 0.3 bar. The pre-setting can be increased to max. 0.6 bar. The control curve as displayed in Fig. 4 moves in parallel to the pre-setting value.

In some special cases, e.g. heating systems with unrestricted TRVs, the flow can additionally be throttled by reducing the pre-setting value of the balancing valve.

Table 4. Effect of different valve pre-settings on k_{vs} -value

DN	Pre-setting of Balancing Valve						
	1.5	1.4	1.2	1.0	0.8	0.6	0.4
10	1.50	1.45	1.35	1.25	1.15	0.95	0.70
15	1.50	1.45	1.35	1.25	1.15	0.95	0.70
20	3.50	3.40	3.30	3.10	2.80	2.45	1.80
25	3.50	3.40	3.30	3.10	2.80	2.45	1.80
32	—	—	—	5.50	5.20	4.45	—
40	—	—	—	5.50	5.20	4.45	—

NOTE: The V5010 Kombi-3-plus BLUE or V5032 Kombi-2-plus balancing valve has to be pre-set to 1.5 (sizes DN10...DN25) or to 1.0 (sizes DN32...DN40) when used with the V5012C Kombi-DP diaphragm unit. Lower pre-settings can be used to further throttle down the flow, see Table 4 on page 5.

Installation and Setup

Changing the pre-setting

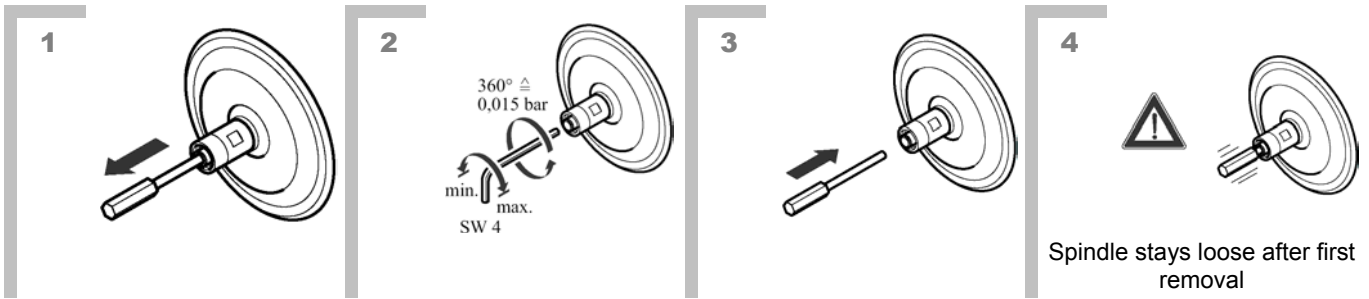

Note: Factory setting is 0.1 bar for V5012C0103 and 0.3 bar for V5012C0306.

Installation

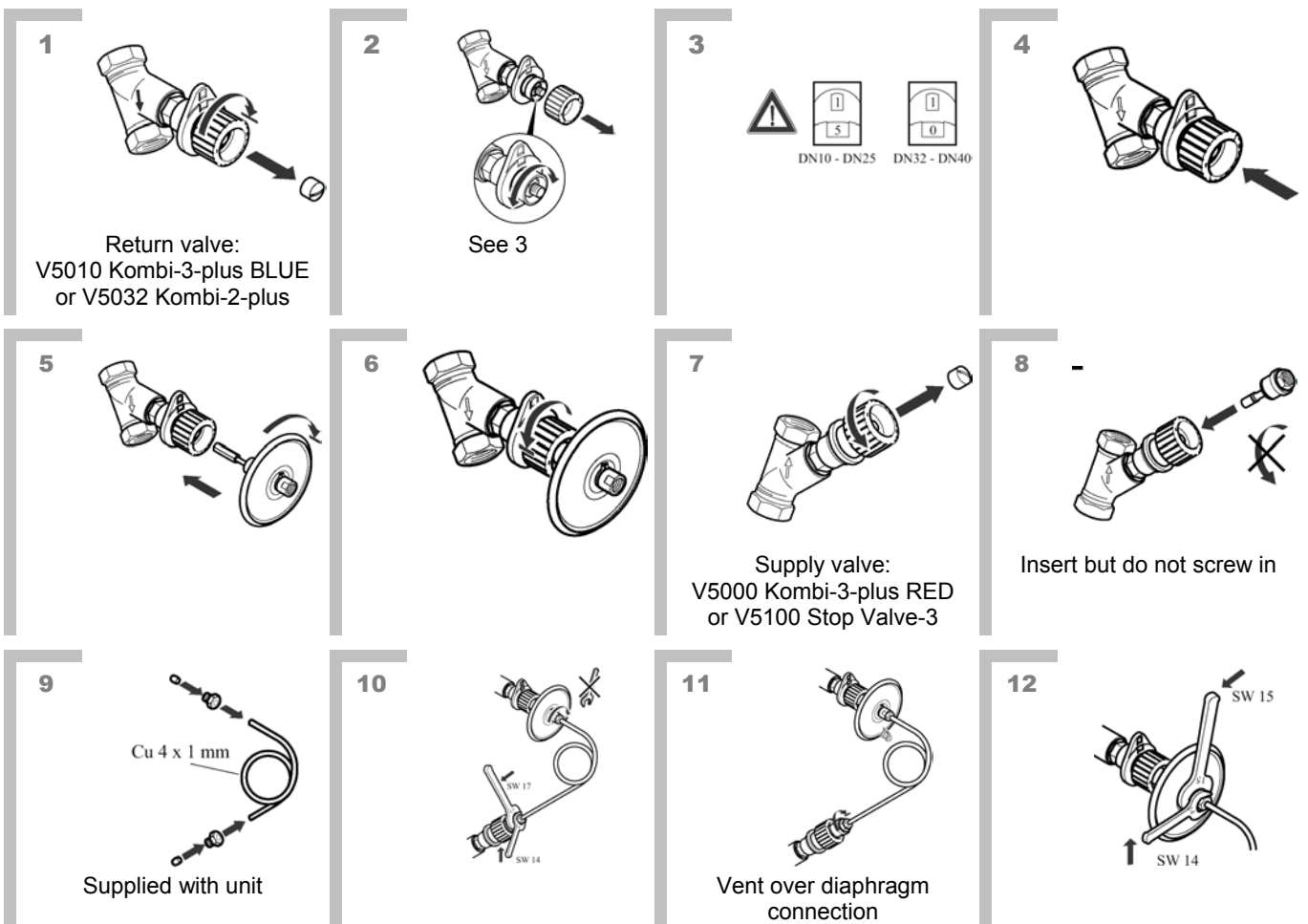

For more information on Honeywell Balancing and Pipeline Valves see www.honeywell-valvesizing.com.

Robinex AG
Alte Distelbergstrasse 1
5035 Unterentfelden

Tel. 062 787 70 00
Fax. 062 787 70 01
info@robinex.ch